

4GB

 **EMERSON™**

3.5"
Color Display



Music



Video



Pictures

MP3
Music & Video Player

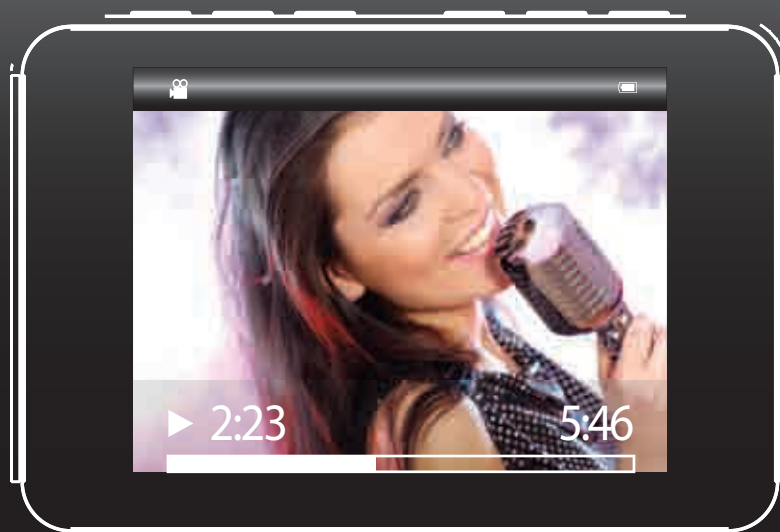

User Guide

EMP313-4

 **TABLE OF CONTENTS**

IN THE BOX	1
FCC INFORMATION	2
FCC Part 15	2
INTRODUCTION	3
IMPORTANT SAFETY PRECAUTIONS	4
FEATURES	5
LOCATION OF CONTROLS	6
CONNECTING TO A COMPUTER	7
System requirements	7
PC connection	7
Disconnecting the USB cable	8
CHARGING THE BATTERY	9
MICRO SD	9
BASIC OPERATION	10
Turning on/off	10
Adjusting the volume	10
Lock / unlock buttons	10
Reset the player	10
TRANSFERRING MEDIA TO THE PLAYER	11
MAIN MENU	12
MUSIC	13
Playing music	13
Using the music menu	14
Customizing the equalizer	15

Create a new Playlist	15
Add to a Playlist	15
Lyrics display	15
VIDEO	16
Playing video	16
PICTURES	17
Using the picture menu	18
RECORDING	19
Recording voice	19
Playing recordings	19
E-BOOK (TEXT READING)	20
Reading a text	20
Using the text reader menu	20
BROWSER	21
Deleting files	21
SETTINGS	21
TROUBLESHOOTING	23
SPECIFICATIONS	24
WARRANTY INFO	25

IN THE BOX

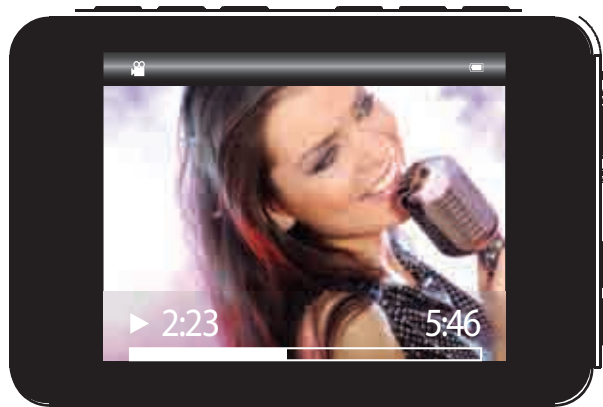

MP3 Music and Video Player

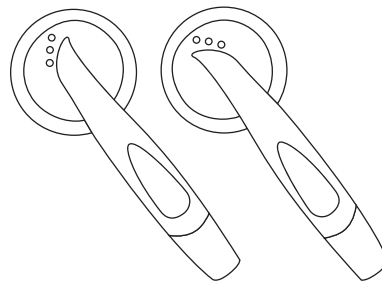

Stereo Headphones

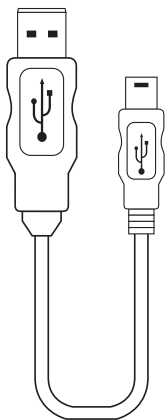

USB 2.0 Cable
(for battery charging
and high speed data transfer)



CD



Quick Start Guide

 **FCC INFORMATION**

FCC Part 15

This equipment has been tested and found to comply with the requirements for a Class B digital device under Part 15 of the Federal Communications Commission (FCC) rules. These requirements are intended to provide reasonable protection against harmful interference in a residential installation. This equipment generates, uses and can radiate radio frequency energy and, if not installed and used in accordance with the instructions, may cause harmful interference to radio communications. However, there is no guarantee that interference will not occur in a particular installation. If this equipment does cause harmful interference to radio or television reception, which can be determined by turning the equipment off and on, the user is encouraged to try to correct the interference by one or more of the following measures:

- Re-orient or relocate the receiving antenna.
- Increase the separation between the equipment and receiver.
- Connect the equipment into an outlet on a circuit different from that to which the receiver is connected.
- Consult the dealer or an experienced radio/TV technician for help.

Changes or modifications to this equipment not expressly approved by the party responsible for compliance could void the user's authority to operate the equipment.

INTRODUCTION

Congratulations on purchasing the Emerson MP3 Music & Video Player.

Before using the player, read this manual thoroughly and keep it for future reference.

This manual contains important safety information and correct operation instructions. Read the manual carefully before you use the player in order to avoid any confusion.

Copyright Information

Trademarks and trade names used in this instruction manual are owned by their respective companies or organizations.

Unauthorized duplication of any recordings whether downloaded from the internet or made from audio CDs is a violation of copyright laws and international treaties.

The making of unauthorized copies of copy-protected material, may be an infringement of copyrights and constitute a criminal offence. This equipment should not be used for such purposes.

IMPORTANT SAFETY PRECAUTIONS

Always follow these basic safety precautions when using your player. This will reduce the risk of product damage and personal injury.

- Do not disassemble, repair or modify the player by yourself. Refer servicing to qualified personnel.
- This device contains a built- in battery, do not dispose of in fire.
- In the event that the battery is leaking, do not handle the device with your bare hands. Contact the service center for help since the liquid may remain in the player. If your body or clothes had contact with the battery liquid, wash it off thoroughly with water. Also, if some liquid gets into your eyes, do not rub your eyes but immediately wash them with clean water, and consult a doctor.
- Keep the player away from direct sunlight and any direct heat source.
- Do not expose the unit to rain or moisture.
- Do not use the player in dry environments to avoid static.
- Never apply heavy impact on the player, or place it on a magnet.
- Route the USB cable so that people and pets are not likely to trip over it.
- Disconnect the USB cable from the computer when you do not use the player for a long time.
- Clean only with a dry cloth. Make sure the player is turned off before cleaning. Do not use a liquid cleanser.
- Be sure to back up your files to avoid data loss.

Precautions in using the headphones

- Do not use the headphones while driving an automobile or riding a bicycle. It is dangerous, and against the law. To avoid an accident, do not turn up the volume of the headphones too high while walking.
- It is not recommended that you use the headphones at a high volume for an extended time, as this may cause hearing damage.



FEATURES

- 3.5 inch color display (320 x 240)
- 4 GB Memory
- Micro SD card slot (up to 8 GB additional memory)
- Built-in stereo speaker
- USB 2.0 high speed connection
- Stores and plays music, video, and pictures
- Text reading (txt format)
- Digital voice recording (built-in microphone)
- Folder navigation
- Li-ion rechargeable battery
- Supports MP3 / WMA / FLAC / APE / OGG / WAV music formats
- Supports WMV / RMVB / MPEG - 1 / MPEG - 4 / FLV / DIVX / XVID video formats

LOCATIONS OF CONTROLS

1. [▼] - **Down button:** Volume down
2. [▲] - **Up button:** Volume up
3. [▶/||] - **Play button:** Play / Pause / Confirm
4. Screen display
5. Headphone jack
6. Mini-USB connector
7. Microphone
8. [↶] - **Exit button / Previous screen**
9. [◀] - **Previous button:** Pprevious track / Fast rewind
10. [▶] - **Next button:** Next track / Fast forward
11. Micro SD card slot
12. [MENU] - **Menu button:** Main menu / Select an option
13. [POWER] - **Power ON/Off button**
14. Reset hole
15. Speaker (listen to music or video without headphones)

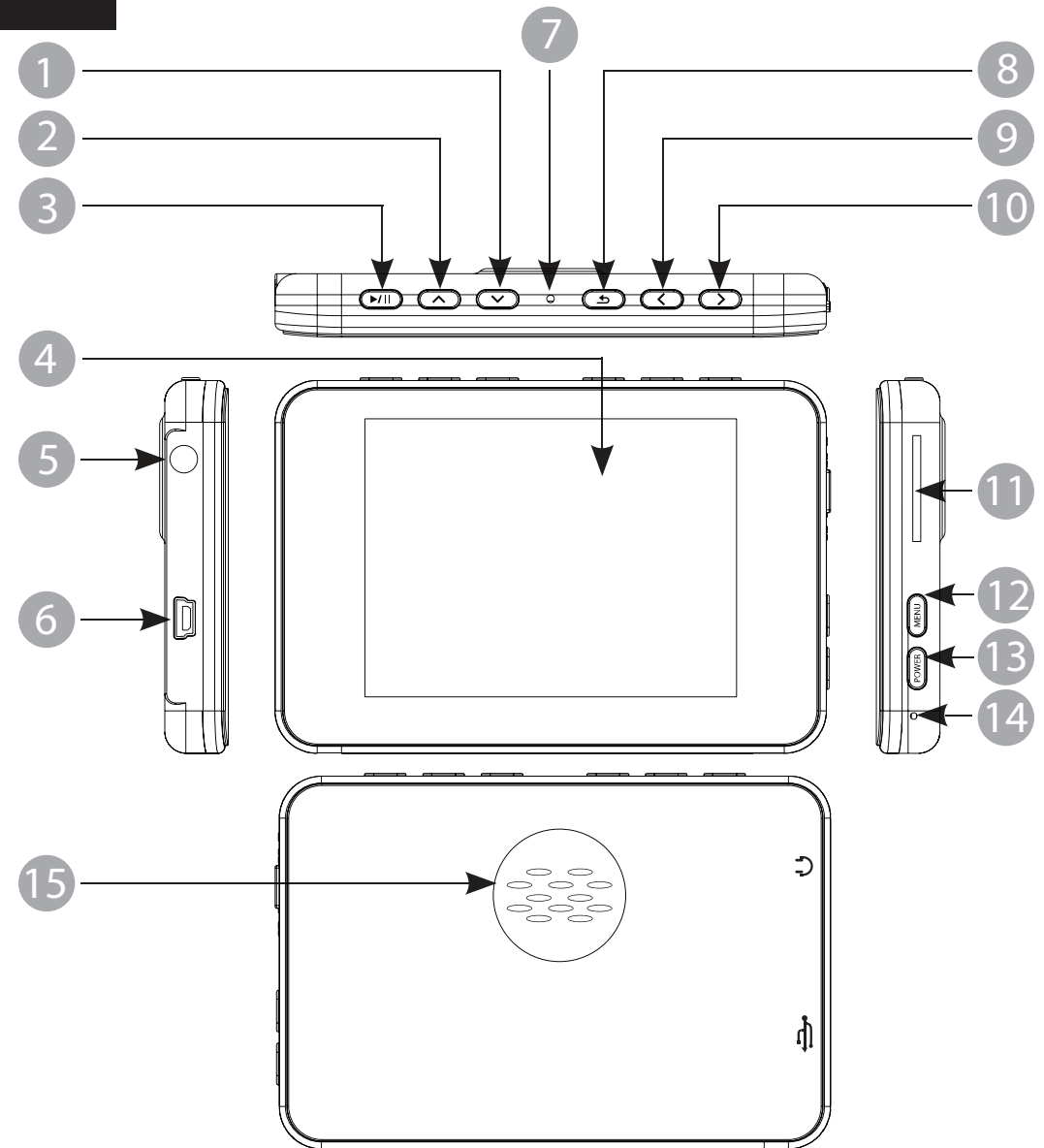

CONNECTING TO A COMPUTER

System requirements

Your computer system must meet the following specifications:

- Pentium 200MHz or above
- Microsoft Windows 2000/ME/XP/Vista
- USB port supported

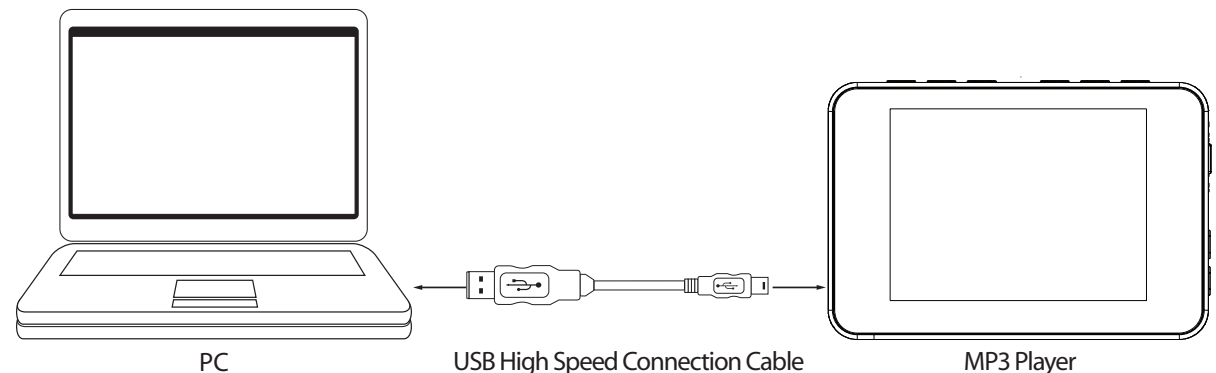

PC connection

In order to enjoy the multimedia capabilities of your **MP3 Player**, you have to first copy your favorite files from your PC to its internal memory. Connect your **MP3 Player** to the computer using the included USB 2.0 cable. The device will be detected automatically without installing any driver. Once detected, you can read/write to the device's memory just as if you were using a regular disk drive.

Make sure your computer is powered on, and follow the steps below to connect the player to your computer.

1. Plug the larger USB connector of the USB cable into the USB port on the computer.
2. Plug the other end (small) of the USB cable to the player.
3. The computer system detects "New hardware" and starts to install the driver automatically. Wait for the system to finish the installation.

When it has finished, "**MP3 EMERSON**" will be created in "**My Computer**".

Important: To avoid any data loss, always perform a safe USB device extraction before disconnecting the USB cable from the PC. In Windows XP, for example, you can find the safe extraction icon in the task bar next to the system clock.

Disconnecting the USB cable

After completing the file transfer, please disconnect the USB cable the following way:

1. Double click the green arrow "Safely Remove Hardware" in the task bar on the bottom right of the window.
2. Select "USB Device" and click "Stop".
3. When the "Stop a Hardware device" appears, click "OK" to disconnect the USB mass storage device, and unplug the player safely.

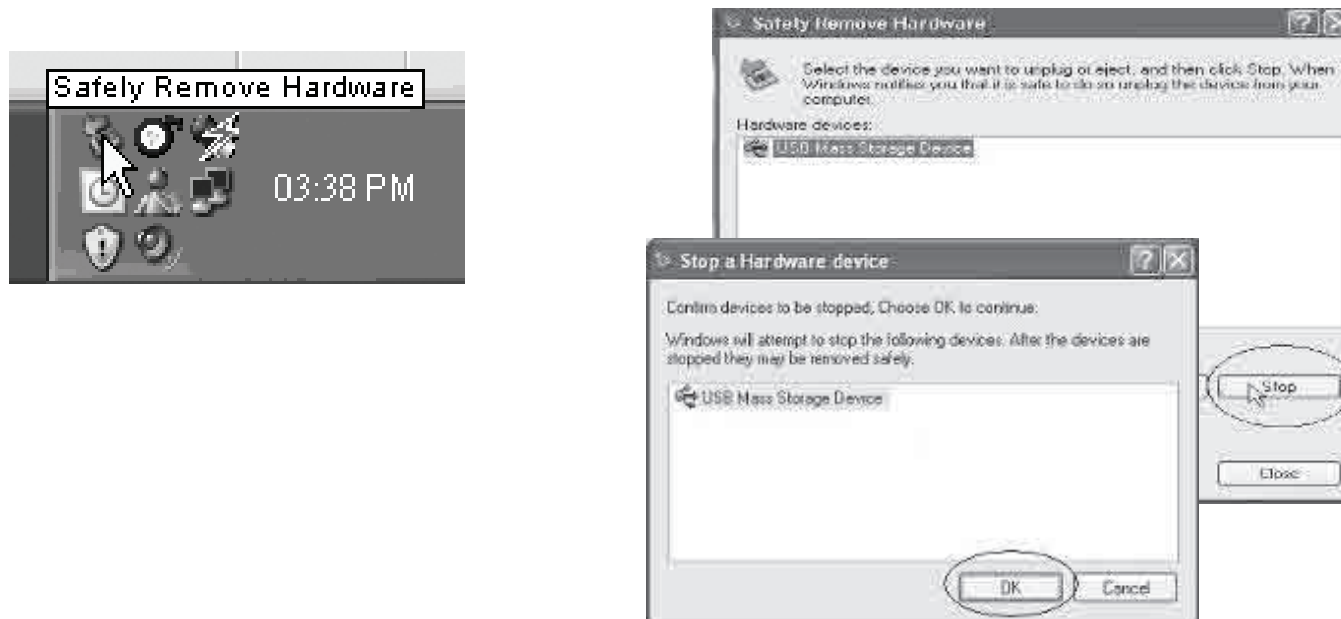

CHARGING THE BATTERY

Your **MP3 Player** has an integrated rechargeable Li-ion battery. It is recommended to fully charge the player before using it for the first time. Recharge the battery by connecting the player to a computer using the included USB 2.0 cable.

Charging time is between 3-5 hours, depending if the player is powered off or working. To keep the battery in good condition, we recommend not charging it for more than 8 hours.

Battery level indication:     
Full Two-thirds full Half full Low Empty

Important:

- *Fully charge it before you use the player for the first time or when you haven't used it for a long time.*
- *Charge the player immediately when the "Low battery" message is displayed.*
- *Do not over charge or discharge the player. Over charging or discharging will shorten the battery life.*
- *The battery could be over discharged if the player is not used for a long time (over three months). To avoid over discharge, fully charge the player every three months and always keep the voltage of the battery above 50 %.*

MICRO SD

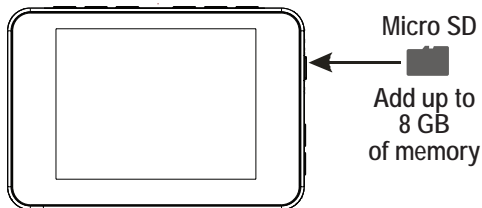

The player includes a Micro SD card slot that enables you to add up to **8 GB** of additional memory to your player.

1. Insert the Micro SD card into the card slot with the metallic contacts facing towards the front of the player, and gently push it in until it clicks.
2. To access the  Micro SD card, select "SD Card" from the main menu, and press the [▶/||] button.
3. Use the [^] or [v] buttons to select a file or folder, and press the [▶/||] button to open the folder, or play/view the file.
4. To remove the card, gently push it in until it pops out.

Note:

- *Do not use force while inserting the memory card*
- *Do not remove the card during data transfers*

BASIC OPERATION

Turning on/off

Make sure the player is charged, and the headphones are connected correctly.

- To turn on the player, press and HOLD the [POWER] button.
- To turn the player off, press and HOLD the [POWER] button.

Adjusting the volume

- To increase the volume, press the [^] button while music, or video is playing.
- To decrease the volume, press the [v] button while music, or video is playing.

Lock / unlock buttons

The buttons of the player are locked when not used for a certain period of time.

This feature prevents you from accidentally pressing the buttons while using the player on the move. To unlock the buttons press and HOLD the [▶/||] button.

To adjust and configure the keylock settings, select **Settings > Screen Settings > Keylock timer**.

Reset the player

If a malfunction of the player occurs, take a metal pin, or use the end of a paper clip, and press it into the RESET hole to re-initialize the system of your player.

NOTE: The player's backlit display will shut after a certain period of inactivity. To adjust, select: **Settings > Screen Settings > Backlight**.
To turn on the display, press the [POWER] button.

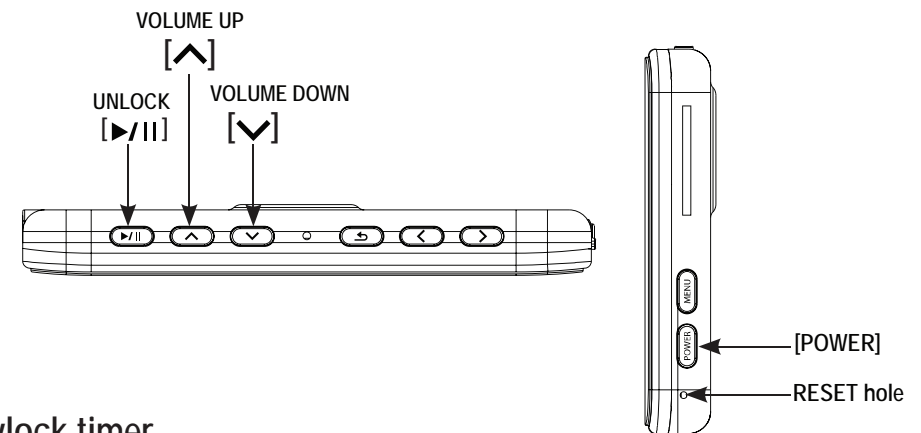

TRANSFERRING MEDIA TO THE PLAYER

The MP3 Player is capable of storing, displaying, and playing your favorite music, pictures, and video.

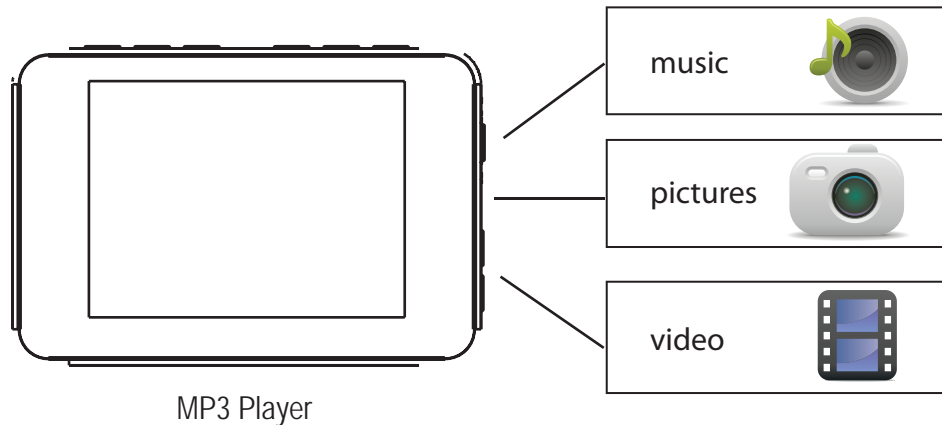

Transferring media to the player

To transfer media from your computer, perform the following steps:

1. Connect the MP3 player to the USB port of your computer.
2. Open "Windows Explorer" or "My Computer", and locate "MP3 EMERSON".
3. Select the files on your computer, and simply move it into "MP3 EMERSON" in the usual way (drag-and-drop, copy-and-paste). After copying is completed, the data will be available on the MP3 player.

We recommend using *Windows Media Player* to organize and transfer music, pictures, and videos to your player. For more information regarding *Windows Media Player*, please refer to the *Quick Start and Media Transfer Guide*, or the included CD

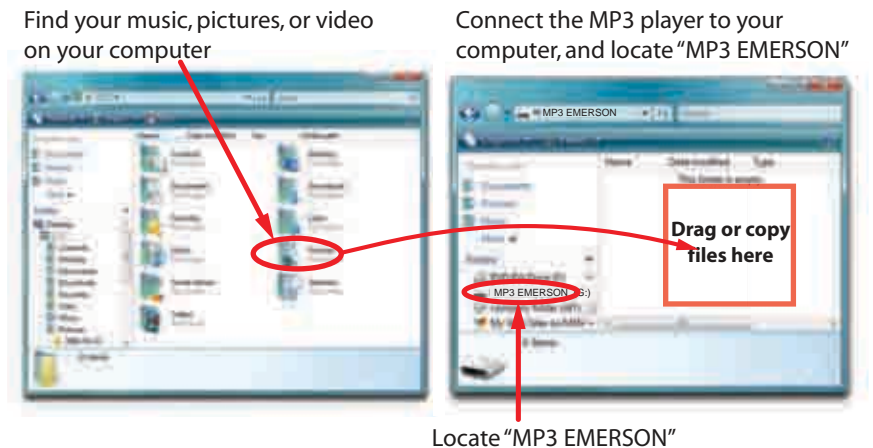

Note: Please do not disconnect the USB cable during loading, it may cause malfunction of the player and the files.



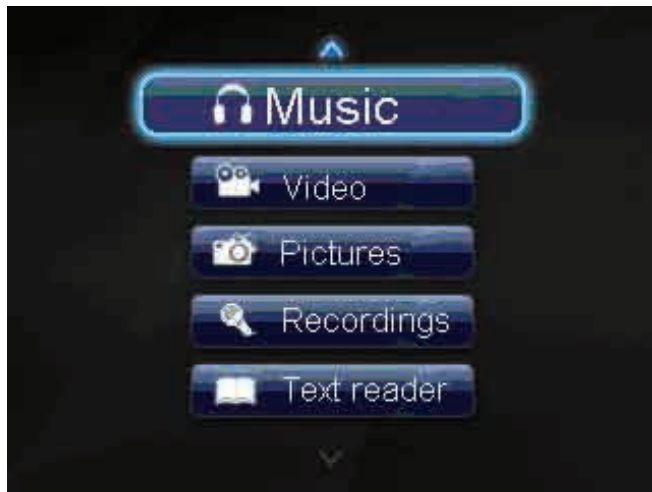







MAIN MENU



Once you turn on the player, the main menu appears. You may also use the [] button to return to the main menu from other modes.

1. Use the [] or [] buttons to select: **"Music"**, **"Video"**, **"Pictures"**, **"Recordings"**, **"Text Reader"**, **"Folder View"**, **"Settings"**, and **"Sd Card"** (if an SD card is inserted in the player).
2. Press the [] button to enter the desired option.

ICON	MAIN MENU ITEMS	DESCRIPTION	ICON	MAIN MENU ITEMS	DESCRIPTION
	Music	Play songs		Text reader	Display text
	Video	Play videos		Folder view	View files and folders of the player
	Pictures	View pictures		Settings	Customize the settings of your player
	Recordings	Voice recordings		Sd Card (SD card must be inserted in the player)	Play songs, videos, pictures, or texts saved in the Micro SD card

MUSIC

Playing music

Store and playback your favorite songs and organize them by playlists, artist, and other options. See “**TRANSFERRING MEDIA TO THE PLAYER**” (page 11) and follow the steps below to transfer, playback and organize your music.

1. Select “**Music**” from the main menu, and press the [▶/||] button.
2. Use the [^] or [v] buttons to select “**All Songs**”, “**Artists**”, “**Albums**”, “**Genres**” or “**Playlists**”, and then press the [▶/||].
3. Use the [^] or [v] buttons to select a song, and then press the [▶/||]. The music playback interface appears on the screen.



While the music is playing, you can:

- **Pause / Resume Playing:** Press the [▶/||] button to pause playing. To resume playing, press the [▶/||] button again.
- **Skip Tracks:** Use the [◀] or [▶] buttons to skip to previous / next track.
- **Fast Search:** Press and **HOLD** the [◀] button to fast rewind within a track, press and **HOLD** the [▶] button to fast forward within a track.
- **Adjust Volume:** Use the [^] or [v] buttons to increase / decrease the volume.
- **Exit:** Press the [↶] button to go back to the previous screen.
- **Music menu:** Press the [MENU] button to enter the music menu.

Using the music menu

1. Press the [MENU] button while a song is in the play or pause mode to enter the music menu.
2. Use the [▲] or [▼] buttons to select "Playmodes", "Add to Playlist", "EQ Settings", "Lyrics Display", or "Delete".
3. Press the [▶/||] button to enter, and confirm selections.
4. Press the [↶] button to exit.

MUSIC MENU	OPTION	OPTION	DESCRIPTION
Use the [▲] or [▼] buttons, then [▶/].	Use the [▲] or [▼] buttons, then [▶/].	Use the [▲] or [▼] buttons, then [▶/].	
Playmodes	Shuffle All	Off	Play all songs in order
		On	Shuffle all songs
	Repeat	Off	Play all songs in order once
		Repeat One	Repeat the current or selected song
		Repeat All	Repeat all songs
Add to Playlist	Playlist 1		Add current or selected song to Playlist 1
	Playlist 2		Add current or selected song to Playlist 2
	Playlist 3		Add current or selected song to Playlist 3
	Playlist 4		Add current or selected song to Playlist 4
	Playlist 5		Add current or selected song to Playlist 5
EQ Settings	MS PlayFX	3D	3D sound effect
		Bass	Bass sound effect
		Balance	Balance sound effect
	EQ	Off	No sound effect
		MS PlayFX	MS PlayFX sound effect
		Rock	Rock sound effect
		Pop	Pop sound effect
		Jazz	Jazz sound effect
		Classical	Classical sound effect
		Hip Hop	Hip Hop sound effect
Custom	Custom sound effect		
Lyric display	On		Display lyrics
	Off		Lyrics display is turned off
Delete	Cancel		Cancel delete
	Delete		Delete current or selected song

Customizing the equalizer:

1. While a song is in the play or pause mode press the [MENU] button.
2. Select **EQ Settings > EQ > Custom**, and then press the [▶/||] button.
3. Use the [◀] or [▶] buttons to navigate among value bars.
4. Use the [^] or [v] buttons to adjust the value, and confirm with the [▶/||] button.
5. Press the [↶] button to return to previous screens.

NOTE: You may also choose one of the preset equalizer settings within the EQ menu.

Create a new Playlist:

1. Enter **Music > Playlists**.
2. Press the [MENU] button to “Delete a playlist” or “Create new playlist”.
3. Use the [^] or [v] buttons to select “Create new playlist”, and then press the [▶/||] button to confirm.

Add to a Playlist

1. Select the song you would like to add to a playlist.
2. Press the [MENU] button.
3. Use the [^] or [v] buttons, and select “Add to Playlist”, and press the [▶/||] button.
4. Select the playlist you would like the song added to and press the [▶/||] button to confirm.

Lyrics Display

This player supports lyrics display while the music is playing.

NOTE: Only lyrics in LRC format can be displayed.

VIDEO

Playing video

Store and playback your favorite videos or movies to watch and enjoy anywhere!
See “TRANSFERRING MEDIA TO THE PLAYER” (page 11) and follow the steps below:

1. Select “Video” from the main menu, and press the [▶/||] button.
2. Use the [^] or [v] buttons to select a video, and press the [▶/||] button. The video playback interface appears on the screen.
3. Press the [↶] button to exit and return to the video file list.

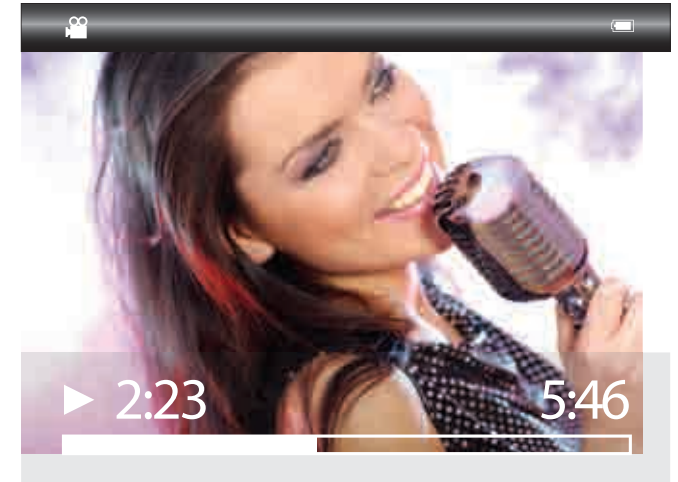

While a video is playing, you can:

- **Pause / Resume Playing:** Press the [▶/||] button to pause playing. To resume playing, press the [▶/||] button again.
- **Skip videos:** Use the [◀] or [▶] buttons to skip to previous / next video.
- **Search:** Press and **HOLD** the [◀] button to fast rewind within a video, press and **HOLD** the [▶] button to fast forward within a video.
- **Adjust Volume:** Press the [^] or [v] buttons to increase / decrease the volume.
- **Exit:** Press the [↶] button to return to the video file list.

PICTURES

Viewing pictures

The MP3 Player is capable of storing and displaying your favorite pictures.

See “TRANSFERRING MEDIA TO THE PLAYER” (page 11) and follow the steps below:

1. Select “Pictures” from the main menu, and then press the [▶/||] button.
2. Use the [^] or [v] buttons to select “All Pictures”, and press the [▶/||] button.
All pictures stored on the player are displayed on the screen as thumbnails.
3. Use the [^], [v], [◀] or [▶] buttons to select a picture, and press the [▶/||] button.
The picture is displayed on the screen.
4. Press the [↶] button to exit, or return to previous screens.



While viewing pictures, you can:

- **Skip pictures:** Use the [◀] or [▶] buttons to skip to the previous / next photo.
- **Rotate the picture:** Use the [^] or [v] buttons repeatedly to rotate the picture.
- **Access the picture menu:** Press the [MENU] button to enter the picture menu.
- **Exit:** Press the [↶] button to exit, or return to previous screens.

Using the picture menu

While viewing pictures, press the [MENU] button to enter the picture menu.

1. Use the [^] or [v] buttons to select “**Start Slideshow**”, “**Slideshow Settings**”, “**Add To Favorites**”, or “**Delete Picture**”.
2. Press the [▶/||] button to enter, and confirm selections.
3. Press the [↶] button to return to previous screens.
 - **Start Slideshow:** Start a slideshow from the current picture by pressing the [▶/||] button.
 - **Slideshow Settings:** Press the [▶/||] button, and use the [^] or [v] buttons to select “Slideshow music”, “Time per slide”, “Shuffle”, or “Repeat”, and confirm with the [▶/||] button.
 - **Add to Favorites:** Save the current picture or selected picture to “Favorite Pictures” by pressing the [▶/||] button.
 - **Delete Picture:** Use the [^] or [v] buttons to select “Delete”, and press the [▶/||] button to delete the current picture or selected picture.

RECORDING

Recording Voice

1. Select “Recordings” from the main menu, and press the [▶/||] button.
2. Use the [^] or [v] buttons and select “Start Voice Recording”, and press the [▶/||] button.
The voice recording interface appears on the screen.
3. Press the [▶/||] button to start and pause recording.
4. Press the [↶] button, and select “Yes”, and press the [▶/||] button to save the recordings.

NOTE:

- The recorded voice files are saved in the **VOICE** folder of the MP3 player as WAV files (format: VOICE001.WAV, VOICE002.WAV).
- Voice recording is automatically stopped when the memory of the player is full or the battery power is no longer sufficient.
- Date for recordings are automatically saved.

Playing recordings

1. Select “Recordings” from the main menu, and then press the [▶/||] button.
2. Use the [^] or [v] buttons to select “Recording Library”, and press the [▶/||] button.
3. Use the [^] or [v] buttons to select “Voice Recordings”, and press the [▶/||] button. The voice playback interface appears on the screen.
4. Use the [^] or [v] buttons to select the file you want to play, and press the [▶/||] button.
5. Press the [↶] button to exit, or return to previous screens.

Note: File selecting, file searching, and playback function in the Voice mode are same as the Music mode.

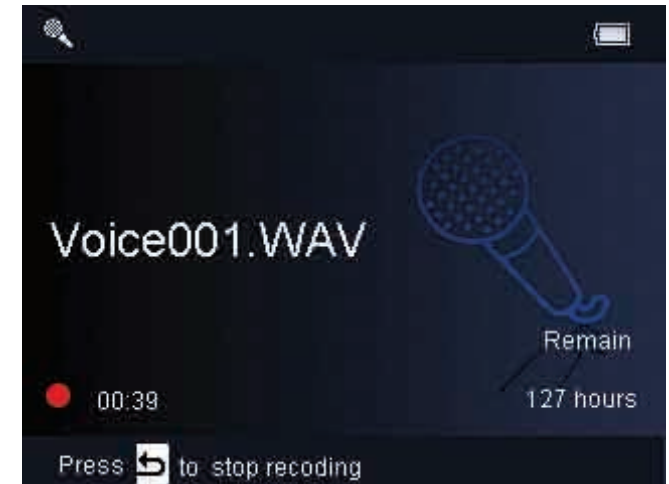

E-BOOK (TEXT READING)

Reading a text

This player only supports E-Book in TXT format. Other formats must be saved as TXT format before transfer.

1. Select “Text Reader” from the main menu, and press the [▶/||] button.
2. Use the [^] or [v] buttons to select a folder or file, and press the [▶/||] button to open the folder or view the selected file.
3. Press the [↵] button to exit, or return to previous screens.

While a TXT file is open, you can:

- **Page Up/Down:** Use the [^] or [v] buttons to move up/down.
- **Fast browse:** Press and **HOLD** the [^] or [v] buttons to fast browse.
- **Exit:** Press [↵] button to back to previous screen.
- **Access the text reader menu:** Press the [MENU] button to enter the text reader menu.

Using the text reader menu

While reading a text, press the [MENU] button to enter the text reader menu.

1. Use [^] or [v] buttons to select “Bookmarks”, “Delete”, “Auto sliding” or “Browse Mode”.
 2. Press [▶/||] button to enter, and confirm selections.
 3. Press [↵] button to exit, or return to previous screens.
- **Bookmarks:** “Add to Bookmark”, “Load Bookmark”, “Delete Bookmark”.
 - a) **Add to Bookmark:** Press the [▶/||] button to bookmark the current page.
 - b) **Load Bookmark:** Use [^] or [v], and press the [▶/||] button to load the selected bookmark.
 - c) **Delete Bookmark:** Use [^] or [v] to select “Confirm”, and press the [▶/||] button to delete the selected bookmark.
 - **Delete:** Use [^] or [v] to select “Confirm”, and press the [▶/||] button to delete current book.
 - **Auto sliding:** Use [^] or [v] to select an interval time, and press the [▶/||] button to auto slide the pages.
 - **Browse Mode:** Use [^] or [v] to select a mode, and press the [▶/||] button to confirm.

BROWSER

This handy function allows you to directly choose the music / video / image / e-book folder or file you want to play or view.

1. Select **“Folder View”** from the main menu, and press the [▶/||] button.
2. Use the [^] or [v] buttons to select the previous or next folder or file, and press the [▶/||] button to open your selection.
3. Select a file using the [^] or [v] buttons, and press the [▶/||] button to start playback or open the file.

Deleting Files

• From your player

1. Select **“Folder View”** from the main menu, and press the [▶/||] button.
2. Use the [^] or [v] buttons to select the folder or file you wish to delete.
3. Press the [MENU] button, and select “Delete”, and press the [▶/||] button.
4. Choose “Confirm”, and press the [▶/||] button to delete the file.
5. Press the [↶] button to return to the previous screen.

OR

• From your computer

You can easily delete music, picture, or video files by connecting your video player to the computer and selecting **“MP3 EMERSON”** from Windows Explorer or “My Computer”, or click on “Open Folder” to view files from the “AutoPlay” option window. Simply select the file and delete it as you would delete any other file from your computer.

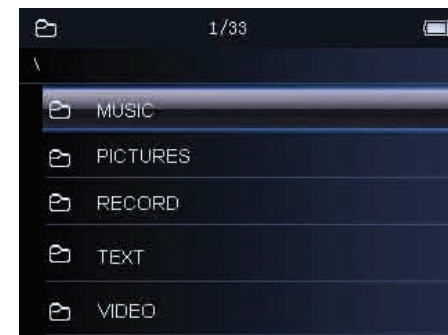

SETTINGS

To customize and configure your **MP3 Player**, follow the steps bellow:

1. Select **“Settings”** from the main menu, and press the [▶/||] button.
2. Use the [^] or [v] buttons to select a setup option, and then press the [▶/||] button to enter the submenu.
3. Use the [^] or [v] buttons to select an option, and confirm with the [▶/||] button.
4. Press the [↶] button to exit, or return to previous screens.

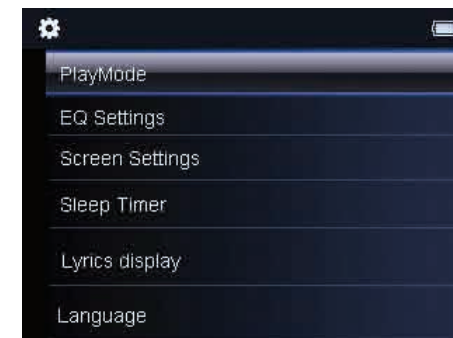

SETTINGS

SETTINGS MENU	OPTION	OPTION	DESCRIPTIONS
Play Mode	Shuffle All	Off	Play all songs in order
		On	Shuffle all songs
	Repeat	Off	Play all songs in order once
		Repeat One	Repeat the current or selected song
Repeat All		Repeat all songs	
EQ Settings	MS PlayFX	3D	3D sound effect
		Bass	Bass sound effect
		Balance	Balance sound effect
	EQ	Off	No sound effect
		MS PlayFX	MS PlayFX sound effect
		Rock	Ideal for Rock music
		Pop	Ideal for Pop music
		Jazz	Ideal for Jazz music
		Classical	Ideal for Classical music
		Hip Hop	Ideal for Hip Hop music
Custom	Customize the equalizer		
Screen Settings	Backlight	Set the backlight time The available options include: Always on, 10 Seconds, 30 Seconds, 60 Seconds	
	Brightness	Adjust the brightness of the screen	
	Keylock timer	Set the keylock time The available options include: 10 Seconds, 30 Seconds, 5 Minutes, 10 Minutes, Never	
Sleep Timer	Set the sleep time The available options include: Off, 15 Minutes, 30 Minutes, 60 Minutes		
Lyrics Display	Display lyrics - Off / On		
Language	Choose display language		
Factory Settings	Reset to factory default settings		
Information	Player information		

TROUBLESHOOTING

If you have problems while operating your player, please check the points below before sending it to the service center

Can not power on

- The battery may be exhausted, please recharge the battery

Files can not be transferred to the player

- Check if the driver is installed correctly in the computer by disconnecting and then reconnecting the player to the computer
- Check the connection between the player and PC, and confirm the USB cable is properly connected

No sound from the headphones

- Please ensure the volume is turned up, and the headphones are properly connected
- Check if the format of music file is supported by the player

Can not record

- Check if there is enough memory and battery capacity

Display is in the wrong language

- Please ensure you selected the correct language from the “**Settings** ” menu

The buttons do not work

- The player may be locked. Press and **HOLD** the [▶/||] button to deactivate the lock function
- Press the reset hole with a metal pin to re-initialize the system of the player

My computer is not detecting the MP3 Player with Windows Vista

- There is a USB mass storage devices recognition issue with Windows Vista acknowledged by Microsoft. A solution is available in the Service Pack 1 which may be downloaded from Microsoft's website

I cannot display my .jpg files

- Many digital cameras and image editing softwares add hidden data to the .jpg files. This data can prevent your MP3 from loading the images. Try to eliminate them by saving the file with another name.

SPECIFICATIONS

Display	3.5" color display	Resolution	320 x 240 4:3
Audio Format	MP3 / WMA / FLAC / APE / OGG / WAVE	Size: L x W x H (mm)	104 x 70.5 x 12 mm
Photo Format	JPG / BMP	Weight	< 100 g (without accessories)
Video Format	WMV / RMVB / MPEG1, 4 / FLV / DIVX / XVID	Frequency response	
MP3 bit Rate	8Kbps ~ 320 Kbps	Dynamic current	
WMA bit Rate	8Kbps ~ 320 Kbps	Power Off current	
PC connection	USB 2.0 (High speed)	Storage condition	Humidity < 85%, -20 ~ 60° C
Built-in memory	4 GB	Working condition	Humidity < 85%, -10 ~ 40° C
Power source	Built-in Lithium battery	Power out	
EQ	Rock / Pop / Jazz / Classical / Hip Hop / Custom / 3D / Bass / Balance		

LIMITED WARRANTY

In the unlikely event that this product is defective, or does not perform properly, you may within ninety (90) days from your original date of purchase return it to the authorized service center for repair or exchange.

TO OBTAIN WARRANTY SERVICE:

- Provide proof of the date of purchase within the package (Dated bill of sale)
- Prepay all shipping costs to the authorized service center, and remember to insure your return.
- Include a return shipping address (no P.O. Boxes), a telephone contact number, and the defective unit within the package.
- Describe the defect or reason you are returning the product.

Your product will be repaired or replaced, at our option, for the same or similar model of equal value if examination by the service center determines this product is defective. Products received damaged as a result of shipping, will require you to file a claim with the carrier.

**The shipping address of the authorized
service center is:**

 **Southern Telecom Inc.
ATTN: Returns Department
14-C 53rd Street
Brooklyn, NY 11232**

Should you have any questions or problems concerning this product, please contact our customer service department at:

 **1-877-768-8483 (Toll Free)**

Monday - Thursday: 9AM - 5PM (EST)

Friday: 9AM - 3PM (EST)

or

via e-mail at

 **cs@southerntelecom.com**

To obtain service after the warranty period, please e-mail cs@southerntelecom.com with product information, date of purchase and nature of the problem. Customer service will reply to the e-mail with service instructions.

Warranty service not provided:

This warranty does not cover damage resulting from accident, misuse, abuse, improper installation or operation, lack of reasonable care, and unauthorized modification. This warranty is voided in the event any unauthorized person opens, alters or repairs this product. All products being returned to the authorized service center for repair must be suitably packaged.

Limitation of Warranty:

- THE WARRANTY STATED ABOVE IS THE ONLY WARRANTY APPLICABLE TO THIS PRODUCT. ALL OTHER WARRANTIES, EXPRESS OR IMPLIED (INCLUDING ALL IMPLIED WARRANTIES OF MERCHANTABILITY OR FITNESS FOR A PARTICULAR PURPOSE) ARE HEREBY DISCLAIMED. NO VERBAL OR WRITTEN INFORMATION GIVEN BY SOUTHERN TELECOM INC. IT'S AGENTS, OR EMPLOYEES SHALL CREATE A WARRANTY OR IN ANY WAY INCREASE THE SCOPE OF THIS WARRANTY.
- REPAIR OR REPLACEMENT AS PROVIDED UNDER THIS WARRANTY IS THE EXCLUSIVE REMEDY OF THE CONSUMER, SOUTHERN TELECOM INC. SHALL NOT BE LIABLE FOR INCIDENTAL OR CONSEQUENTIAL DAMAGES RESULTING FROM THE USE OF THIS PRODUCT OR ARISING OUT OF ANY BREACH OF ANY EXPRESS OR IMPLIED WARRANTY ON THIS PRODUCT. THIS DISCLAIMER OF WARRANTIES AND LIMITED WARRANTY ARE GOVERNED BY THE LAWS OF THE STATE OF NEW YORK. EXCEPT TO THE EXTENT PROHIBITED BY APPLICABLE LAW, ANY IMPLIED WARRANTY OF MERCHANTABILITY OR FITNESS FOR A PARTICULAR PURPOSE ON THIS PRODUCT IS LIMITED TO THE APPLICABLE WARRANTY PERIOD SET FORTH ABOVE.

How state law relates to this warranty:

- Some states do not allow the exclusion nor limitation of incidental, consequential damages, or limitations on how long an implied warranty lasts so the above limitations or exclusion may not apply to you..
- This warranty gives you specific legal rights, and you also may have other rights that vary from state to state.

To obtain service after the warranty period, please e-mail cs@southerntelecom.com with product information, date of purchase and nature of the problem. Customer service will reply to the e-mail with service instructions.

Warranty service not provided:

This warranty does not cover damage resulting from accident, misuse, abuse, improper installation or operation, lack of reasonable care, and unauthorized modification. This warranty is voided in the event any unauthorized person opens, alters or repairs this product. All products being returned to the authorized service center for repair must be suitably packaged.

Limitation of Warranty:

- THE WARRANTY STATED ABOVE IS THE ONLY WARRANTY APPLICABLE TO THIS PRODUCT. ALL OTHER WARRANTIES, EXPRESS OR IMPLIED (INCLUDING ALL IMPLIED WARRANTIES OF MERCHANTABILITY OR FITNESS FOR A PARTICULAR PURPOSE) ARE HEREBY DISCLAIMED. NO VERBAL OR WRITTEN INFORMATION GIVEN BY SOUTHERN TELECOM INC. IT'S AGENTS, OR EMPLOYEES SHALL CREATE A WARRANTY OR IN ANY WAY INCREASE THE SCOPE OF THIS WARRANTY.
- REPAIR OR REPLACEMENT AS PROVIDED UNDER THIS WARRANTY IS THE EXCLUSIVE REMEDY OF THE CONSUMER, SOUTHERN TELECOM INC. SHALL NOT BE LIABLE FOR INCIDENTAL OR CONSEQUENTIAL DAMAGES RESULTING FROM THE USE OF THIS PRODUCT OR ARISING OUT OF ANY BREACH OF ANY EXPRESS OR IMPLIED WARRANTY ON THIS PRODUCT. THIS DISCLAIMER OF WARRANTIES AND LIMITED WARRANTY ARE GOVERNED BY THE LAWS OF THE STATE OF NEW YORK. EXCEPT TO THE EXTENT PROHIBITED BY APPLICABLE LAW, ANY IMPLIED WARRANTY OF MERCHANTABILITY OR FITNESS FOR A PARTICULAR PURPOSE ON THIS PRODUCT IS LIMITED TO THE APPLICABLE WARRANTY PERIOD SET FORTH ABOVE.

How state law relates to this warranty:

- Some states do not allow the exclusion nor limitation of incidental, consequential damages, or limitations on how long an implied warranty lasts so the above limitations or exclusion may not apply to you..
- This warranty gives you specific legal rights, and you also may have other rights that vary from state to state.



Manufactured by: AIT Inc. Brooklyn, NY 11232

Emerson and the G-Clef logo are registered trademarks of Emerson Radio Corp. Parsippany, New Jersey USA

© 2009 AIT Inc. All rights reserved

Microsoft, the Windows logo, and Windows Media are either registered trademarks of Microsoft Corporation
in the United States and / or other countries.
